

Article number: 0101163
 Description: Retaining ring A 230 DIN 471
 Spring steel
 Note: Fitted with ZGA pilers

Measures

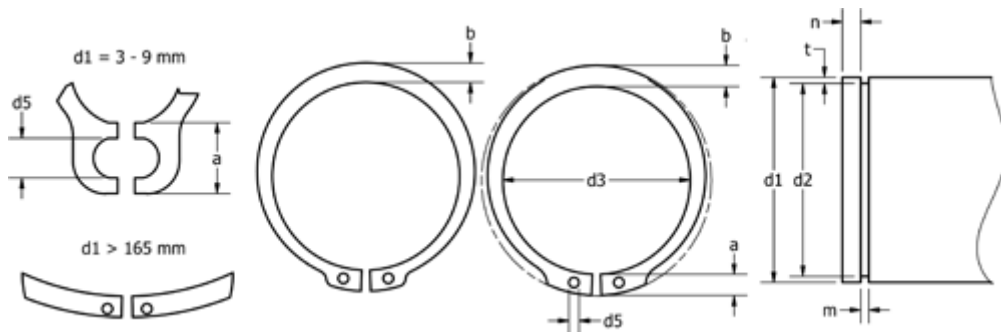

a max	= 14.2	FN kN	= 356.0	s	= 5.00
AN mm ²	= 2140.0	FRg kN	= 55.00	t	= 3.00
b	= 14.0	FR kN	= 548.00	tol	= -0.72
d1	= 230	g	= 6.0	tol	= -0.12
d2	= 224.0	K kN-mm	= 1257.00	tol	= +0,72-1,70
d3	= 218.0	m min	= 5.15	Tong	= ZGA-5
d5 min	= 4.0	n abl x 1000	= 1.0	Weight kg/1000	= 290.000
Description	= A230	Nominal drive	= 9.0		